

# Digital Air Velocity Meter

## DC580



**The Value Leader™**  
[www.testproductsintl.com](http://www.testproductsintl.com)

## **Contents**

<b>Introduction .....</b>	<b>Page 1</b>
<b>General Overview &amp; Guidelines .....</b>	<b>Page 1</b>
<b>Features and Guidelines .....</b>	<b>Page 2</b>
<b>LCD Overview .....</b>	<b>Page 3</b>
<b>Keypad Overview .....</b>	<b>Page 4</b>
<b>Probe Overview .....</b>	<b>Page 5</b>
<b>Turning the DC580 on &amp; Connecting a probe ..</b>	<b>Page 6</b>
<b>Units of Measure Setup Mode .....</b>	<b>Page 7</b>
<b>Duct Type and Size Setup Mode .....</b>	<b>Page 8</b>
<b>Definition of Free Area .....</b>	<b>Page 9</b>
<b>Taking a Measurement .....</b>	<b>Page 10</b>
<b>Selecting Between Air Velocity and Volume ..</b>	<b>Page 11</b>
<b>Storing a Reading .....</b>	<b>Page 11</b>
<b>Recalling a Stored Reading .....</b>	<b>Page 12</b>
<b>Preparing to Traverse a Rectangular Duct ....</b>	<b>Page 13</b>
<b>Time Based Traverse of a Horizontal Duct ....</b>	<b>Page 14 - 16</b>
<b>Point Based Traverse of a Horizontal Duct ....</b>	<b>Page 17 - 19</b>
<b>Preparing to Traverse a Round Duct .....</b>	<b>Page 20</b>
<b>Time Based Traverse of a Round Duct .....</b>	<b>Page 21 -23</b>
<b>Point Based Traverse of a Round Duct .....</b>	<b>Page 24 - 26</b>
<b>Traversing a Grille .....</b>	<b>Page 27-28</b>
<b>Auto Off, Backlight, Hold and Min, Max, Avg..</b>	<b>Page 29</b>
<b>Bluetooth Activation &amp; App Use.....</b>	<b>Page 30 - 34</b>
<b>Specifications .....</b>	<b>Page 35 - 36</b>
<b>Battery Replacement .....</b>	<b>Page 36</b>
<b>Troubleshooting &amp; Care.....</b>	<b>Page 37</b>
<b>Warranty, Service, Calibration .....</b>	<b>Page 37</b>

# Introduction

Thank you for purchasing TPI brand products. The TPI DC580 digital air velocity meter is a state of the art, easy to use air velocity tester designed to display air velocity, air flow, and temperature. It can be used with the TPI DC580 app to generate reports and store readings.

The DC580 can be ordered in several configurations:

<u>Part Number</u>	<u>Description</u>
DC580C1	DC580 w/ Hotwire probe & Carry case
DC580C2	DC580 w/ Vane probe & Carry case
DC580C3	DC580 w/ Hotwire & Vane probes & Carry case

This manual covers all features for the DC580 and the use of both hotwire and vane type probes.

## Features & Guidelines

### Features:

- Measure air velocity and temperature simultaneously
- Field replaceable smart hot wire and vane probes
- Communicate with Android Smart Phone via Bluetooth LE and TPI App
- Display minimum, maximum & average
- Multiple measuring units: m/s, km/h, ft/min, knots, mile/h

### Guidelines:

**Always** allow the DC580 sufficient time to acclimate to the test environment especially when moving from location to location.

**Always** operate the DC580 and probes within the temperature and humidity limits outlined in the specifications area of this manual.

**Never** allow any object to enter the sensor area of the hotwire probe or vane probe.

**Never** attach the DC580 magnetic boot to a hot surface.

# Instrument Overview



**Probe Input Jack** - Connection point for hotwire and vane probes.

**Rubber Boot** - Protects the instrument from accidental damage

**Display** - Large 2 two line LCD display w/ backlight

**Magnets** - Used to attach the DC580 to metal surfaces

**Keypad** - Selects all available functions

**Hanger Hook Attachment Point** - Used with optional boot hook (p/n A103)

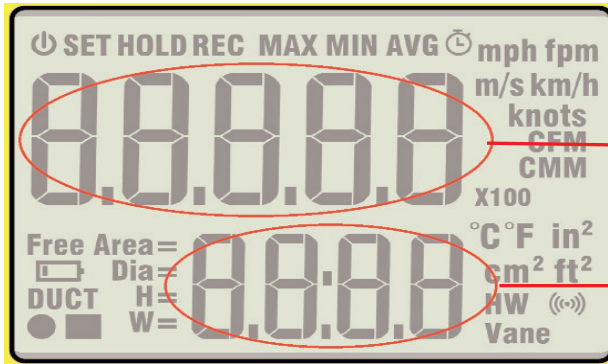

**Hanger Strap Attachment Point** - Used with optional magnetic hanger strap (p/n A124)

# LCD Overview



Air Velocity and Air Flow Volume Display Area

Temperature Display Area

-  Indicates auto power off is active.
- SET** Indicates Set up mode is active.
- HOLD** Indicates Hold is active. Displayed readings freeze.
- REC** Indicates Record mode is active.
- MAX MIN AVG** Indicates the displayed reading is the Maximum, Minimum, or Average measurement.
-  Indicates timed record mode is active.
- mph fpm**  
**m/s km/h**  
**knots**  
**CFM**  
**CMM** Indicates units of measure for air velocity and volume.  
mph = miles per hour, fpm = feet per minute,  
m/s = meters per second, km/h = kilometers per hour, knots  
CFM = cubic feet per minute,  
CMM = cubic meters per minute
- °C °F**  
**in²**  
**cm² ft²**  
**HW** **Vane** **((( )))** C F = Indicates temperature in Celsius or Fahrenheit.  
cm² ft² = Duct size in square centimeters or square inches.  
HW Vane = Indicates probe connection. Hot Wire or Vane.  
((( ))) = Indicates Bluetooth status.
- Free Area =**  
**DUCT** **H =**  
**W =** Free Area = Amount of area blocked by grille, register, etc.  
Dia = Diameter of duct if it is round  
H = Height of duct if it is square or rectangular  
W = Width of duct if it is square or rectangular  
**DUCT** = Duct type, round or square. Also spot record indicator.  
 = Low battery indicator. Replace batteries when displayed.

# Keypad Overview

**HOLD**



Use to navigate up in setup mode menus.

Use to freeze the current reading on the LCD when performing a measurement.



Use to confirm entry when in setup mode menus.

Use to switch between air velocity and air flow when taking measurements.

**MEM**



Use to activate memory mode and store readings.

Use to decrease the parameter in setup mode menus.

Use to activate and deactivate auto power off.



Use to turn the DC580 on and off. (Press and hold)

**DUCT**



Use to setup duct type and size.

Use to navigate left in menu mode.

**REC**



Use to activate time and point record modes and to cycle through min, max, and average readings.

**UNIT**

Use to setup units of measurement for air velocity, air volume, temperature, and duct size.

**RCL**



Use to return to normal operation from recall mode.

Use to navigate right in setup mode menus.

Use to recall and display recorded measurements.

**B/L**



Use to turn the backlight on and off.

Use to activate Bluetooth communication mode.

# Probe Overview

## Hot Wire Probe (Part number A581)



Hot wire probe for the DC580. This probe can be used to measure air velocity and flow inside ducts. The white dot should face into the air stream. The probe can be expanded by pulling out the sensor shaft enabling the probe to extend like an antenna.

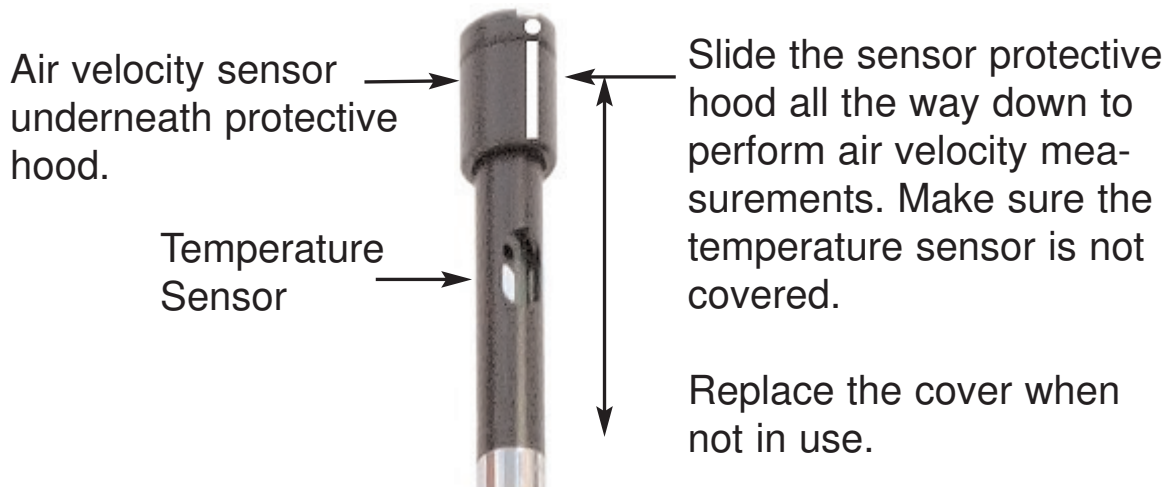

Hot Wire Probe Sensors

---

## Vane Probe (Part number A582)

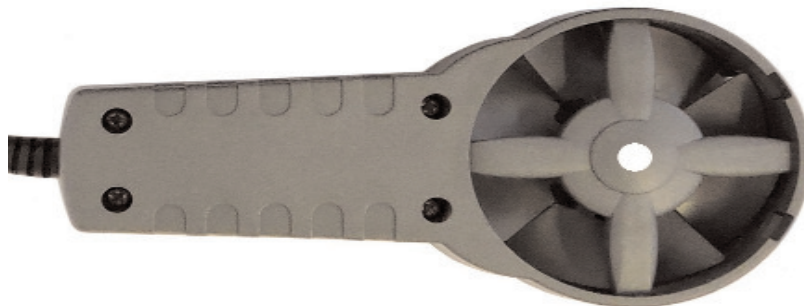

Vane probe for the DC580. This probe can be used to measure air velocity and flow at registers, hoods, and other openings. The white line/dot should face into the air stream.

**Note:** The DC580 can be purchased to include one or both of these probes. These probes are also available for purchase separately. Please see page 36 for information on kits and probes.

## Turning the DC580 on and Connecting a Probe

To turn the DC580 on press and hold the  key for more than two seconds.

If a probe is not connected the display will read 'oPEn'. When this is displayed only the  and  keys operate.

When a probe is connected the DC580 will auto detect which probe has been connected and will act accordingly.

**Hot wire probe** - Make sure the hotwire probe cover has been put into the closed position before connecting the probe. When the hot wire probe is connected a 5 second warm up period will begin and the display will read 'H---d' and display the countdown. After the countdown the DC580 is ready to take measurements. Slide the cover down to the open position and perform tests.











**Vane Probe** - Connect the vane probe and the DC580 is ready to take measurements.

After power is turned on and a probe is connected the DC580 is ready to take measurements. Use the setup modes as needed to adjust units of measure and duct size.



# Units of Measure Setup Mode

Setup the units of measure to be used. The meter will default to these settings upon start up. These can be changed as necessary.

1. Connect a probe to the DC580. Turn the DC580 on by pressing and holding the  key for more than 2 seconds.
2. Press the  key to enter the units of measure setup mode. The air velocity annunciator will begin flashing.
3. Use the  key to cycle through the air velocity units until the required unit is shown. Press the  key to move to the air flow units.
4. Use the  key to cycle through air flow units. CFM and CMM are available. When the desired unit is displayed press the  key to move to temperature units.
5. Press the  key to cycle between temperature units. °F and °C are available. When the desired unit is displayed press the  key to move to duct dimension units.
6. Press the  key to cycle through the duct dimension units. Inches (in), centimeters (cm), meters (m), and feet (ft) are available. When the desired unit of measure is displayed press the  key.
7. The DC580 exits the units setup menu and returns to normal operation.

**Note:** At any time in the above procedure the  key can be pressed to return to normal operation. Units of measure that were not adjusted will remain unchanged.

## Duct Type and Size Setup Mode



When measuring air velocity, the volume of air or airflow can be displayed. This is a calculation based on the duct type and size. For air flow to be accurate the duct size needs to be entered into the DC580.

The units of measure used in the duct size can be set by following the steps outlined in section page 7.







1. Connect a probe to the DC580 and turn it on as outlined earlier.

2. Press the  key to activate duct size entry mode.



3. Use the  key to cycle through the duct type. The types are round, rectangular, and free area. Select free area if measuring at a supply or return with an obstruction like a grille. NOTE: The free area of the duct must be known. This is published by the grille manufacturer.

4. Once the duct type is displayed, =round, =rectangular, or free area press the  key to confirm the selection.

 Round Duct - Use the     keys to enter the diameter of the duct. Press the  key to confirm the selection.

 Rectangular Duct - Use the     keys to enter the height (H) of the duct. Press the  key to confirm the selection.

Use the same keys to enter the width (W) of the duct. Press the  key to confirm the selection.

Free Area - Use the     keys to enter the free area of the duct. Press the  key to confirm the selection.

*For more information on free area please see the next page.*

## Definition of Free Area

Free Area is the total area in which air flows through a supply outlet or a return grille. Free area is the effective area of the outlet or grille and takes into account any restrictions.

If a grille is not used and there is no restriction on the area in which air flows then the free area is equal to the actual area. This is the case when measuring air flow at the middle of a duct, or if the grille is removed from the return or supply duct.

When measuring airflow with a grille in place or restriction present, the free area is the total area minus the area covered by the restriction (grille fins).

Grille manufacturers publish free area specifications and this is the most accurate information to use when setting up your DC580 to measure air flow (volume).

Whenever possible it is best to use free area when entering duct size. This will ensure the most accurate air flow reading.

## Taking a Measurement

1. Insert the hot wire or vane air velocity probe into the DC580. If the hotwire probe is used make sure the sliding cover is over the air sensor. (See page 5)

2. Press and hold the  key until the DC580 turns on.

3. If the hotwire probe is used the DC580 will countdown from 5. During this time the hotwire sensor is being warmed up. If the vane probe is used there will be no countdown.

4, If necessary, set the units of measure and duct size as outlined on page 7 and 8.

5. Insert the air velocity probe into the air stream with the white dot facing into the air. If the hotwire probe is being used make sure the sliding cover is in the down position and the sensor is exposed.

6. The air velocity will be displayed in the upper display and the temperature will be displayed in the lower display.

The most accurate way to take a reading of a duct or grille is to traverse it and take the average reading. The DC580 can do this without the need of manual calculations.

The following pages include instructions for traversing ducts and grilles along with various features and functions available on the DC580.

## Selecting Between Air Velocity and Volume (Air Flow)

When an air velocity is displayed on the DC580 the  key can be pressed to toggle the top display between air velocity and air flow.

Note: The duct size must be entered correctly for the air flow reading to be accurate. Air flow is a calculation based on the duct size and the measured air velocity.

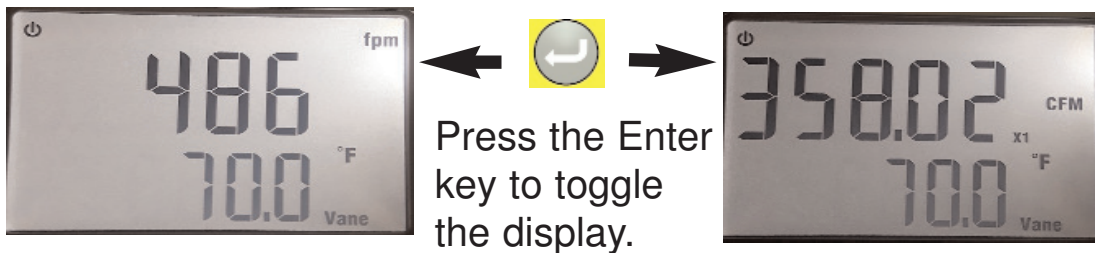





Display shows air velocity in fpm and temperature

Display shows air flow (volume) in CFM and temperature



## Storing a Reading

The displayed reading can be stored in memory. This will store the air velocity, air volume, and temperature.

1. When taking a measurement, once the reading is on the display press the  key.

2. The display will prompt you for a memory location to store the reading. To cancel press the  key or use the  keys to select the memory location to store the reading then press the  key.



**Clearing Memory:** Saving data to the same memory location will write over the data already saved. All locations can be cleared by pressing the  key to enter memory mode then pressing and holding the  key for approximately 3 seconds.





# Recalling a Stored Reading

Stored readings can be recalled and displayed on the DC580.

1. With the DC580 in normal operation press the  key.

2. The display will prompt you to select a memory location to display the stored reading.



3. Use the     keys to select the memory location to display.

4. The stored reading will be displayed.

Press the  key to toggle between the stored air velocity and air volume.



Stored air velocity and temperature displayed.

Press the enter key to toggle the display.



Stored air volume is displayed.

5. Press the  key to exit recall and return to normal operation.

Stored information can also be sent to the DC580 App. The app will display the duct size and also provides the ability to export the data to a CSV file or send a report via email. Please see page 30 for more information on the app.



# Preparing to Traverse a Rectangular Duct

To do a proper airflow measurement (CFM) you should do traverse readings to obtain the true average airflow through the duct. It is recommended to do at least 12 points of measurement. There are two ways to perform this test using the DC580, Time Based Traverse and Spot Based Traverse. Time based is typically easier but both are explained in the next sections.

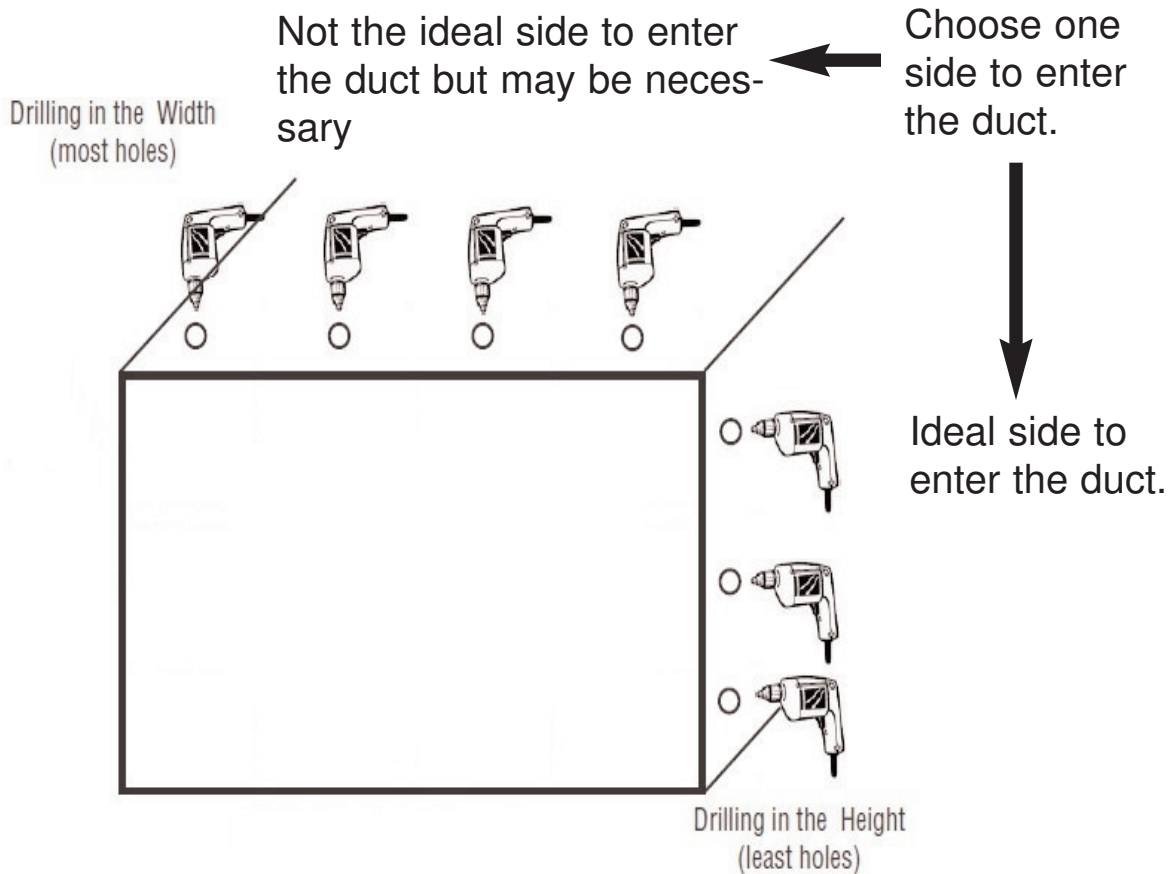
1. You will need to determine the easiest access to take your readings. Normally it is best to enter from the side (Height) of the duct since you will have to drill less holes, but you may have to drill from the bottom (Width) of the duct. See below.



# Time Based Traverse of a Horizontal Duct

1. Insert the hotwire probe into the DC580 and turn the meter on.
2. Enter the duct type and size and prepare the duct for transverse measurements as outlined on page 13.
3. Press the  key. The display will prompt for time or point based traverse. Use the  key to select time based traverse record.

Press the Up Arrow key repeatedly until the timer symbol is seen.



4. Press the  key to confirm the selection.
5. Insert the hotwire probe all the way into the duct at the first hole. Make sure the white dot is facing the air flow. HINT: If you turn the probe you will see the readings change up or down, when the reading is at the highest you are in the proper position.

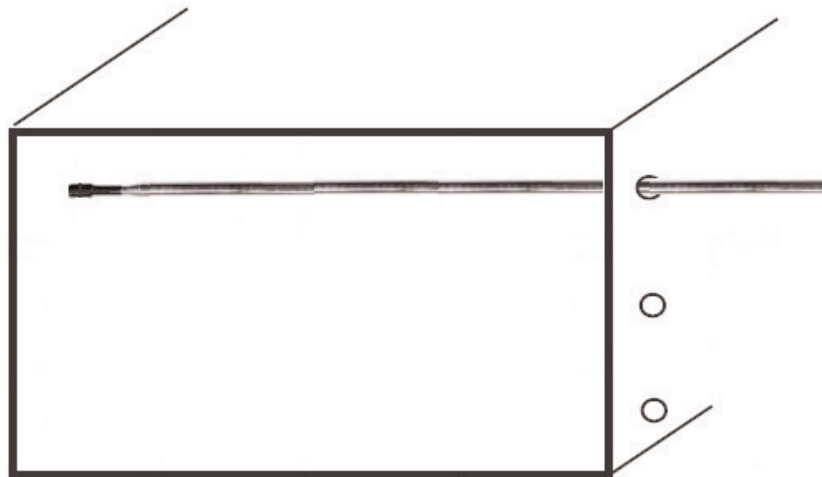



## Time Based Traverse of a Horizontal Duct (Continued)

6. With the probe in place press the  key and the DC580 will begin recording.
7. Slowly pull the probe towards the entrance point of the duct.

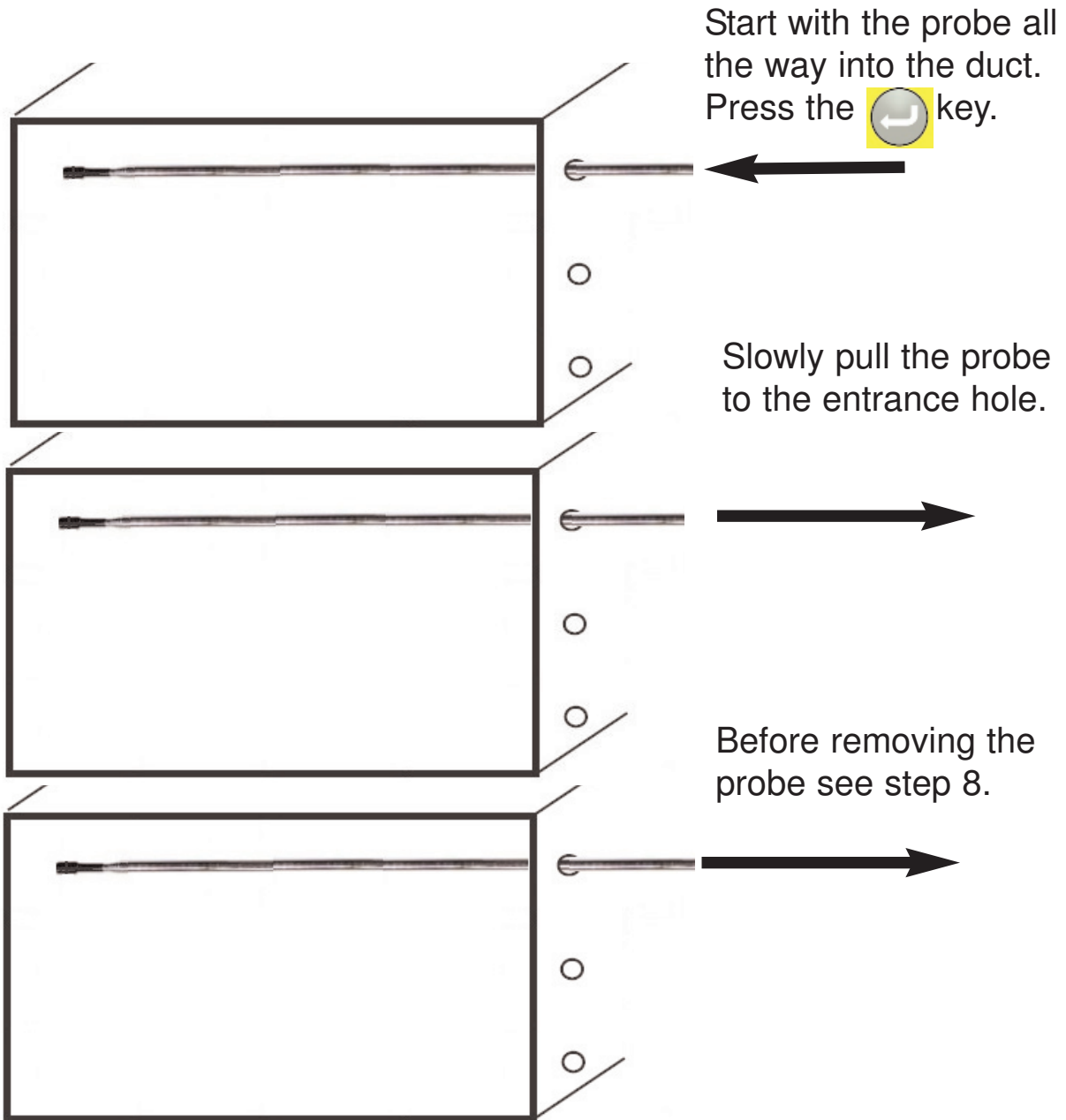



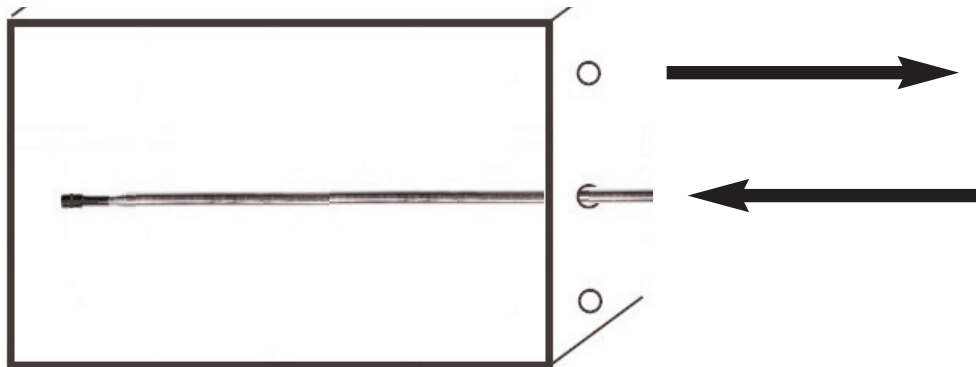

8. Stop at the last measurement point prior to pulling the probe out of the duct. Press the  key to pause the recording.

## Time Based Traverse of a Horizontal Duct (Continued)

9. Pull the probe out and insert it into the next test hole all the way into the duct.





10. Press the  key to begin recording. Repeat these steps for all test holes.
11. When the duct has been completely traversed and prior to pulling the probe out of the last test hole, press the  key to pause the recording.
12. Press the  key to store the readings. See section page 11 on storing readings. This will store the average air velocity, air volume, and temperature readings.
13. If another traverse needs to be made press the  key to clear the timer and begin traversing a duct.

If finished, press and hold the  key to exit record and return to normal operation. The stored readings can be recalled and displayed (see page 12) or sent to the DC580 app (see page 30).

**Note:** At any time during the traverse process when REC is displayed the  key can be pressed to cycle through the minimum (MIN), maximum (MAX), and average (AVG) readings.

# Point Based Traverse of a Horizontal Duct

1. Insert the hotwire probe into the DC580 and turn the meter on.
2. Enter the duct size and prepare the duct for transverse measurements as outlined on the previous page.
3. Press the  key. The display will prompt for time or point based traverse. Use the  key to select point based traverse record.



Press the Up Arrow key repeatedly until the timer symbol is seen.

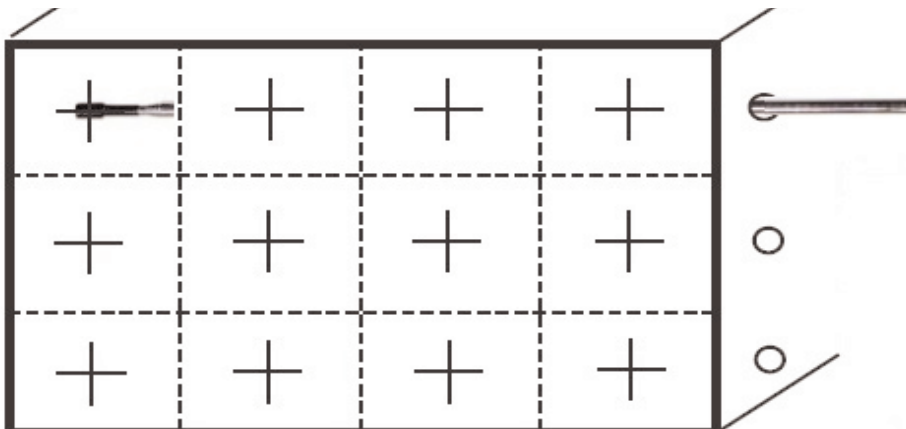

4. Press the  key to confirm the selection.
5. Divide the duct into at least 12 equal boxes, you will need to take the reading in the center of each box. Be sure that the sample points are no more than 4 inches apart from center to center. If needed you can add more sample points (boxes) to cover larger duct sizes. Insert the hotwire probe all the way into the duct at the first hole. Make sure the white dot is facing the air flow.



## Point Based Traverse of a Horizontal Duct (Continued)

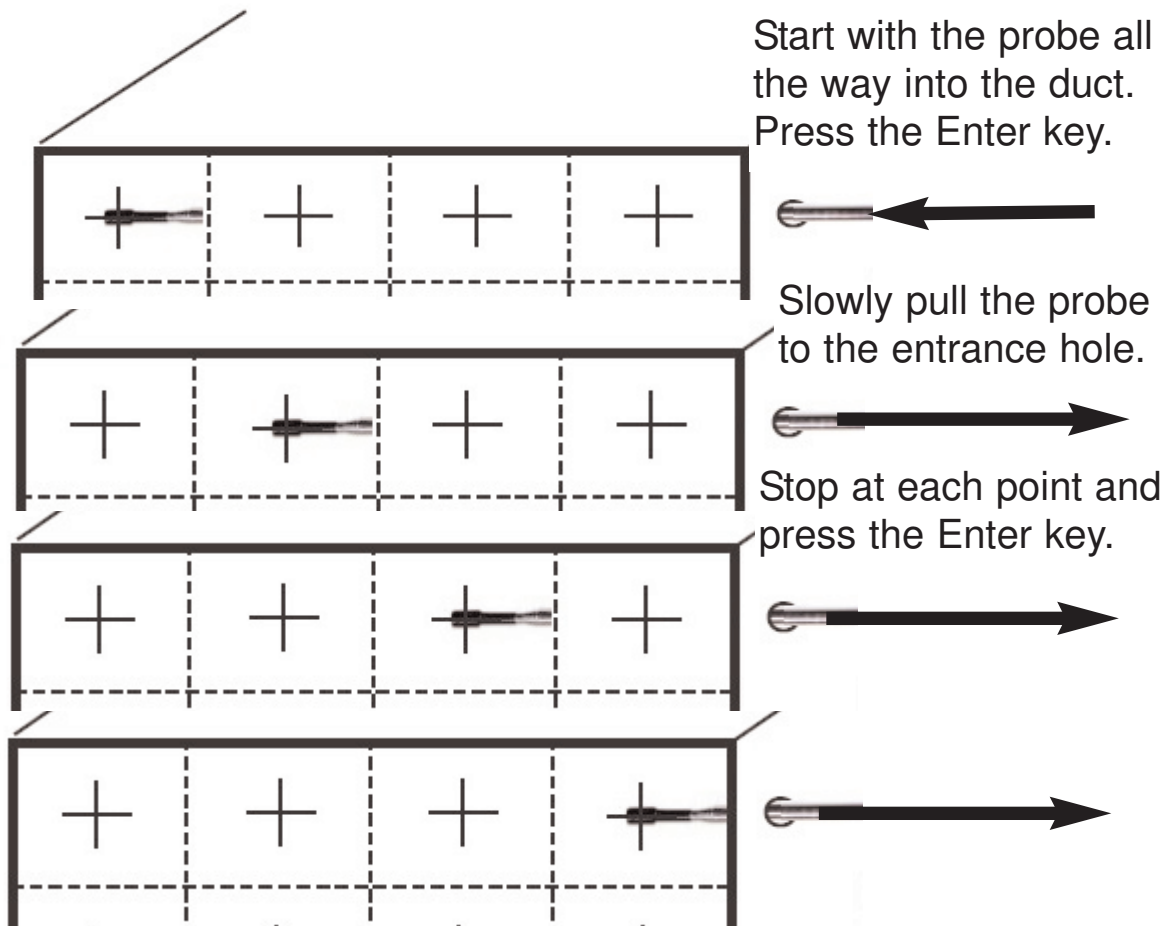

6. With the probe in place press the  key to record the reading.
7. Slowly pull the probe towards the entrance point of the duct. Stop at each point and press the  key to record reading.

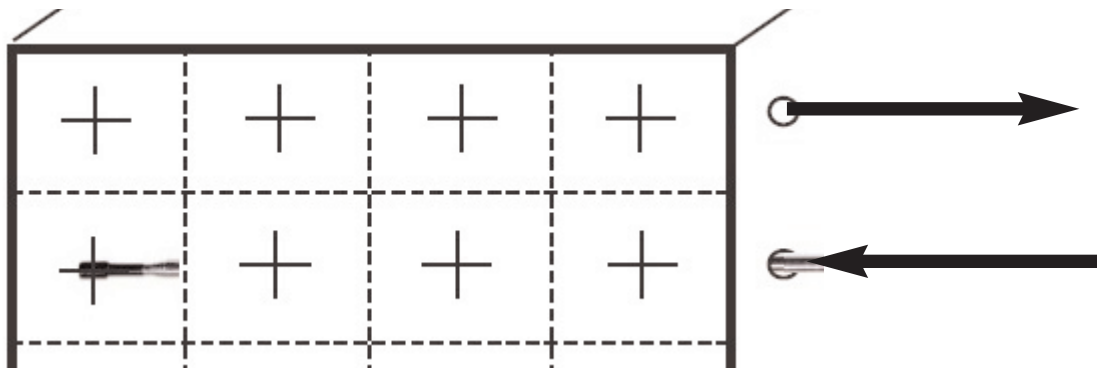

8. Pull the probe out and insert it into the next test hole all the way into the duct.



## Point Based Traverse of a Horizontal Duct (Continued)

9. Press the  key to record the reading. Repeat these steps for all test holes.
10. When the duct has been completely traversed press the  key to store the readings. See section page 11 on storing readings. This will store the average air velocity, air volume, and temperature readings.
11. If another traverse needs to be made press the  key to clear the counter and begin traversing a duct.

If finished, press and hold the  key to exit record and return to normal operation.

**Note:** At any time during the traverse process when REC is displayed the  key can be repeatedly pressed to cycle through the minimum (MIN), maximum (MAX), and average (AVG) readings.

# Preparing to Traverse a Round Duct

## Preparing the Duct

To do a proper airflow measurement (CFM) you should do traverse readings to obtain the true average airflow through the duct. You will need to drill 2 holes at 90 degrees to each other, similar to the drawing below.

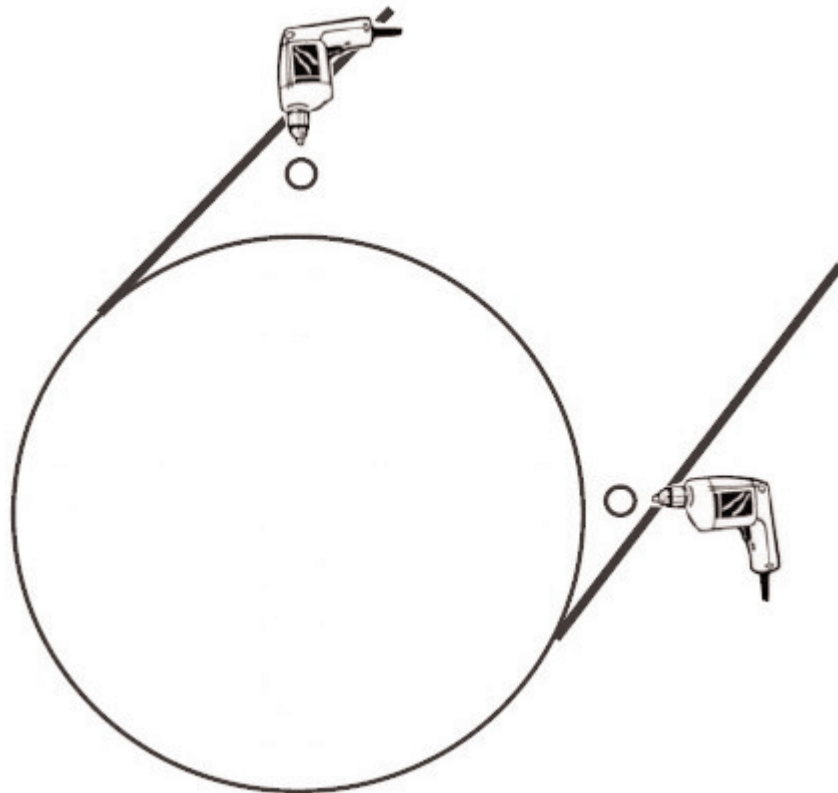



1. Take your measurements by inserting the hotwire probe into the drilled hole. and use the insertion depth chart to determine how far in the duct you will go for each point. Then you will repeat for the other hole.

2. Be sure you have the tip of the hotwire pointed into the flow of air, there is a white dot on the tip, this should be inline with the flow.  
HINT: If you turn the probe you will see the readings change up or down, when the reading is at the highest you are in the proper position.

# Time Based Traverse of a Round Duct

## Using Time Based Traverse Record Function

1. Insert the hotwire probe into the DC580 and turn the meter on.
2. Enter the duct type and size. Prepare the duct for transverse measurements as outlined on the previous page.
3. Press the  key. The display will prompt for time or point based traverse. Use the  key to select time based traverse record.

Press the Up Arrow key repeatedly until the timer symbol is seen.



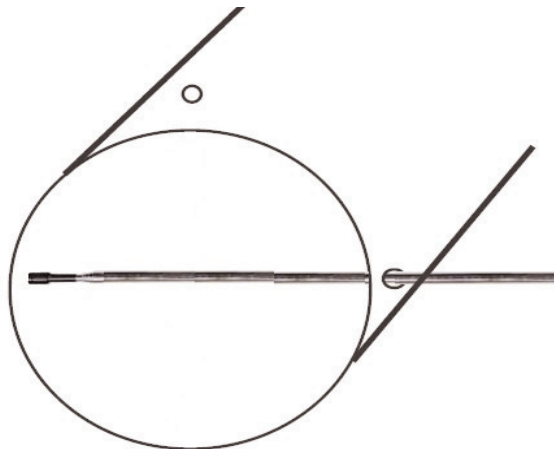

4. Press the  key to confirm the selection.
5. Insert the hotwire probe all the way into the duct at the first hole. Make sure the white dot is facing the air flow.

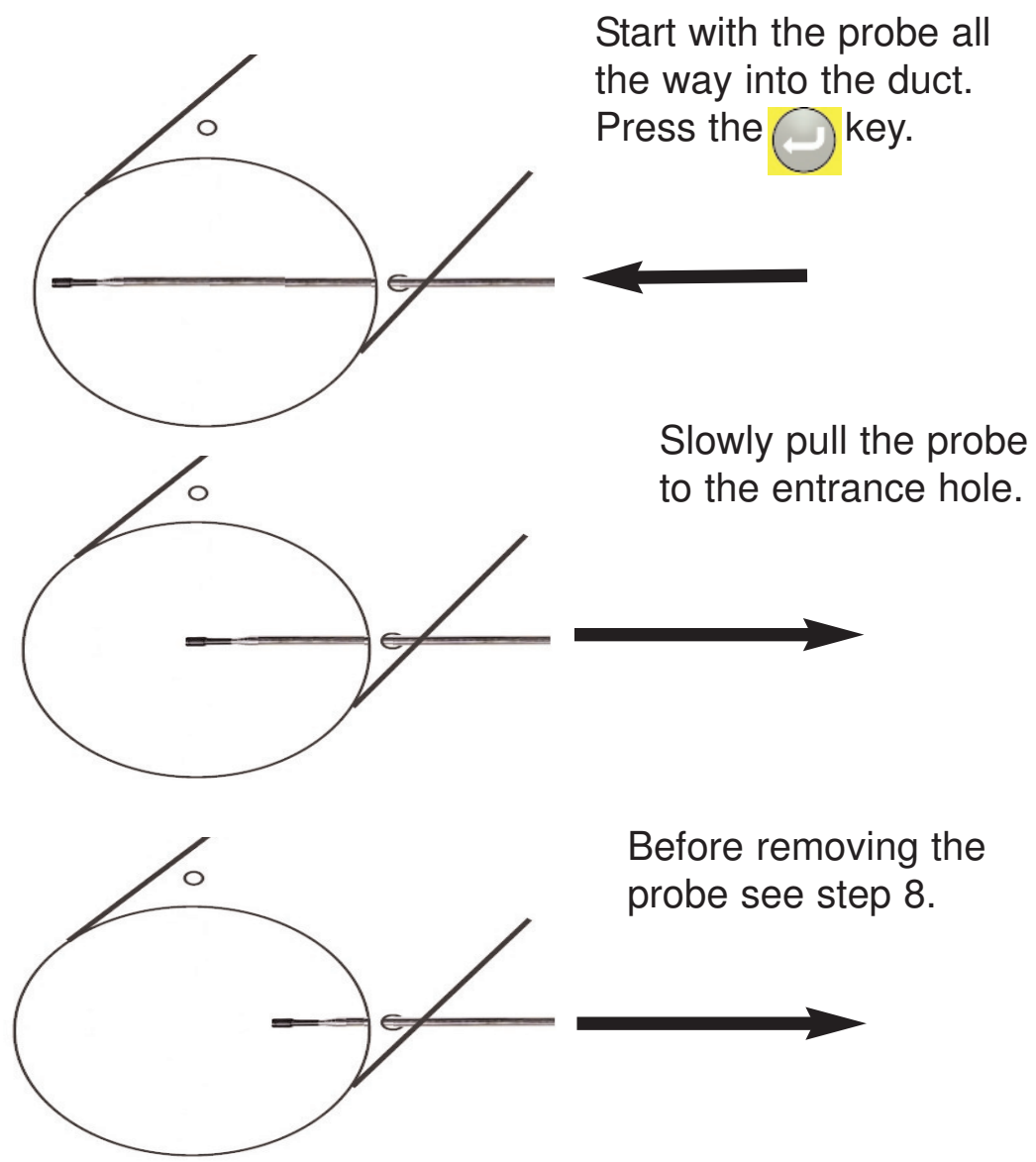

# Time Based Traverse of a Round Duct (Continued)

- 6. With the probe in place press the  key and the DC580 will begin recording.
- 7. Slowly pull the probe towards the entrance point of the duct.







- 8. Stop at the last measurement point prior to pulling the probe out of the duct. Press the  key to pause the recording.

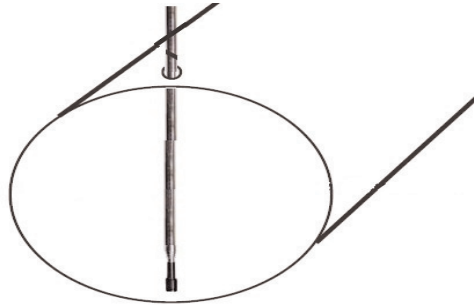

## Time Based Traverse of a Round Duct (Continued)

9. Pull the probe out and insert it into the other test hole all the way into the duct.





10. Press the  key to begin recording. Repeat these steps for all test holes.
11. When the duct has been completely traversed and prior to pulling the probe out of the last test hole, press the  key to pause the recording.
12. Press the  key to store the readings. See section page 11 on storing readings. This will store the average air velocity, air volume, and temperature readings.
13. If another traverse needs to be made press the  key to clear the timer and begin traversing a duct.

If finished, press and hold the  key to exit record and return to normal operation.

**Note:** At any time during the traverse process when REC is displayed the  key can be repeatedly pressed to cycle through the minimum (MIN), maximum (MAX), and average (AVG) readings.

# Point Based Traverse of a Round Duct

1. Insert the hotwire probe into the DC580 and turn the meter on.
2. Enter the duct type and size. Prepare the duct for transverse measurements as outlined on the previous page.
3. Press the  key. The display will prompt for time or point based traverse. Use the  key to select point based traverse record.

Press the Up Arrow key repeatedly until the timer symbol is seen.



4. Press the  key to confirm the selection.
5. Divide the duct into at least 10 equal boxes, you will need to take the reading in the center of each box. Be sure that the sample points are no more than 4 inches apart from center to center. If needed you can add more sample points (boxes) to cover larger duct sizes. Insert the hotwire probe all the way into the duct at the first hole. Make sure the white dot is facing the air flow.

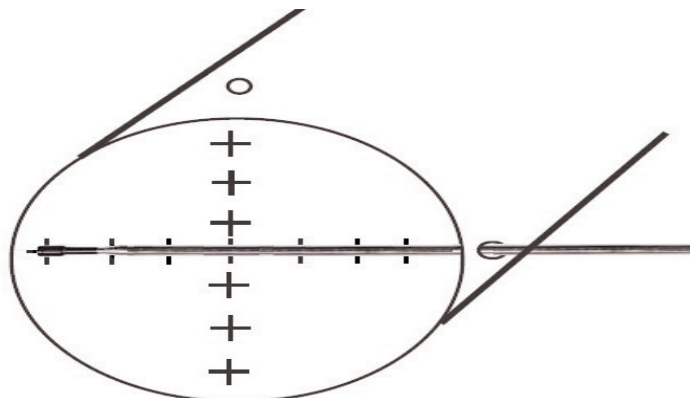

## Point Based Traverse of a Round Duct (Continued)

6. With the probe in place press the  key to record the reading.

7. Slowly pull the probe towards the entrance point of the duct. Stop at each point and press the  key to record reading.

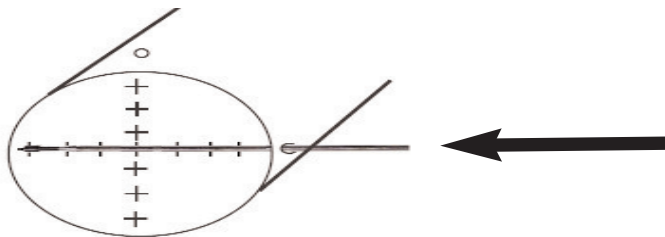

Start with the probe all the way into the duct. Press the  key.

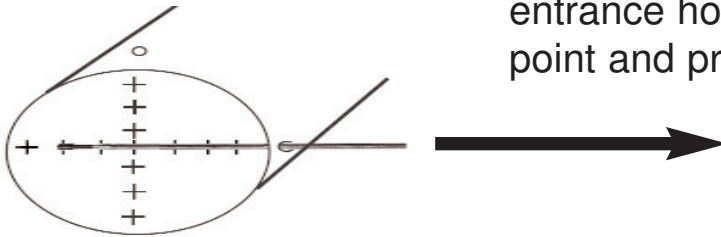

Slowly pull the probe to the entrance hole. Stop at each point and press the  key.

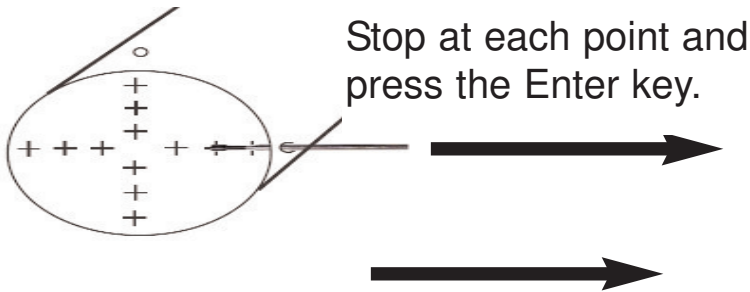



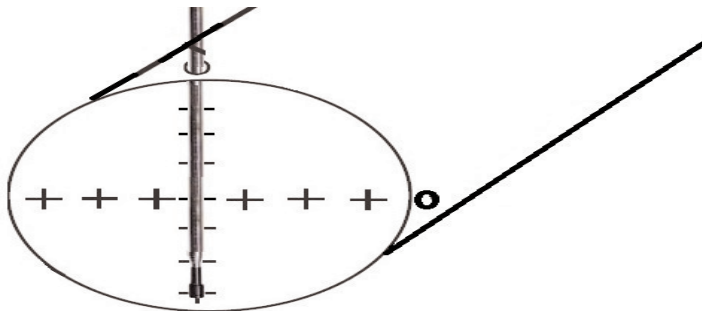

Stop at each point and press the Enter key.

8. Pull the probe out and insert it into the other test hole all the way into the duct.



## Point Based Traverse of a Round Duct (Continued)



9. Press the  key to record the reading. Repeat these steps for all the other test hole.
10. When the duct has been completely traversed press the  key to store the readings. See page 11 on storing readings. This will store the average air velocity, air volume, and temperature readings.
11. If another traverse needs to be made press the  key to clear the counter and begin traversing a duct.

If finished, press and hold the  key to exit record and return to normal operation.

**Note:** At any time during the traverse process when REC is displayed the  key can be repeatedly pressed to cycle through the minimum (MIN), maximum (MAX), and average (AVG) readings.



### 3. Traversing a Grille

#### Using Time Based Traverse Record Function

1. Insert the vane probe into the DC580 and turn the meter on.
2. Enter the duct type and size. Remove the grille if possible or use the free area specification from the manufacturer.
3. Press the  key. The display will prompt for time or point based traverse. Use the  key to select time based traverse record.

Press the Up Arrow key repeatedly until the timer symbol is seen.



4. Press the  key to confirm the selection.
5. Put the vane probe so the white dot is facing the air flow. Press the  key to begin recording.

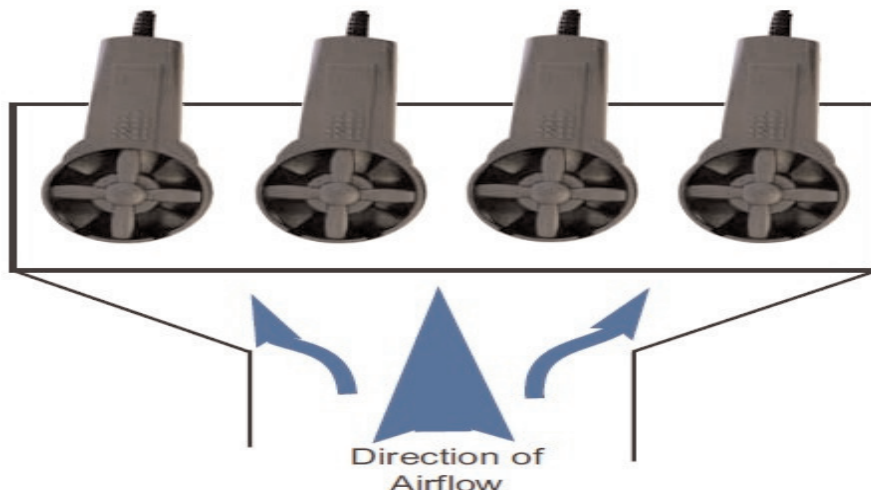

### 3. Traversing a Grille (Continued)

6. Slowly move the vane across the grilled towards the other end.

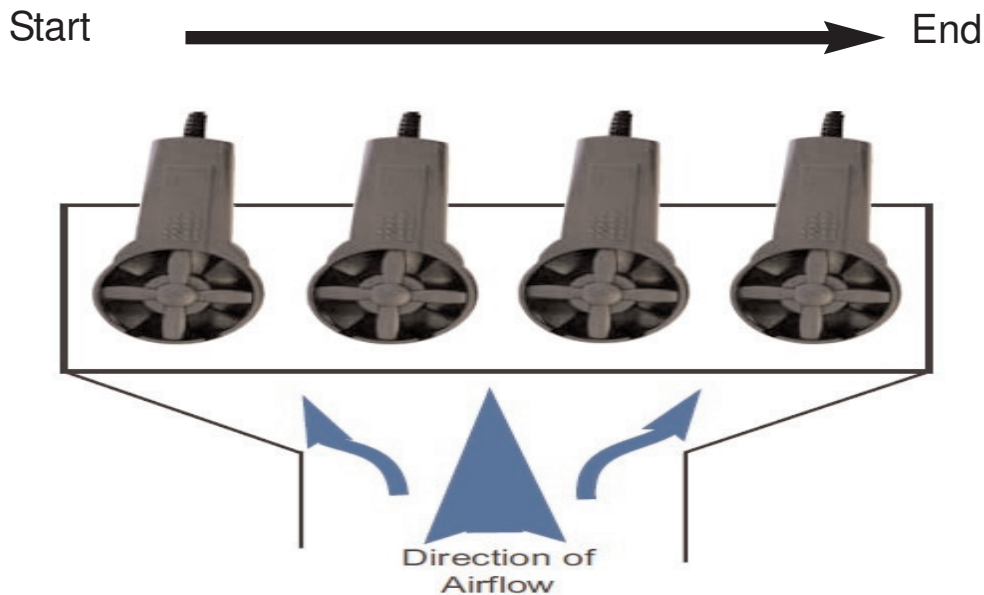

7. Stop at the last measurement point prior to removing the vane.

Press the  key to pause the recording.

8. Press the  key to store the readings. See page 11 on storing readings. This will store the average air velocity, air volume, and temperature readings.



9. If another traverse needs to be made press the  key to clear the timer and begin traversing a duct.

If finished, press and hold the  key to exit record and return to normal operation.

Note: At any time during the traverse process when REC is displayed the key can be pressed to cycle through the minimum (MIN), maximum (MAX), and average (AVG) readings.



## Activate / Deactivate Auto Power Off

The DC580 always defaults to auto power off mode. When auto power off is activated the  annunciator will show in the upper left corner of the display.

To deactivate auto power off from normal operation mode press and hold the key  until the  annunciator turns off. Press and hold the  key again or turn the meter off and on to activate auto power off.

## Turning the Backlight On/Off



The backlight can be turned on to make it easier to see the display in dim areas.

From normal operation mode press the  key to turn the backlight on. Press the  key again to turn the backlight off.

**NOTE:** The backlight will automatically turn off after approximately one minute. This is not adjustable and is done to maximize battery life.

## Turning Display Hold On/Off

The displayed reading can be held on the display if needed.

From normal operation mode during a measurement press the  key to hold the displayed reading. Press the  key to unhold the reading and return to normal operation.





## Minimum, Maximum, Average

The minimum, maximum, and average reading can be displayed using the Record function.

At any time when REC is active like while performing a traverse measurement the  key can be repeatedly pressed to cycle through the minimum (MIN), maximum (MAX), and average (AVG) readings.

# Activate / Deactivate Bluetooth

Bluetooth can be activated in order to communicate with the DC580 app.

1. Activate Bluetooth by pressing and holding the  key until the  annunciator shows in the lower right corner of the display. The annunciator will blink until connected to a phone.
2. Deactivate Bluetooth by pressing and holding the  key until the  annunciator turns off. Turning the DC580 off will also deactivate Bluetooth.

## Using the DC580 App

### Connecting to a DC580

Download the DC580 app from the app store.

1. Insert a probe in the DC580 and turn it on. Activate Bluetooth as outlined above.
2. Open the app. The main screen will be displayed.
3. Tap on “Connect” to search for available DC580 devices.

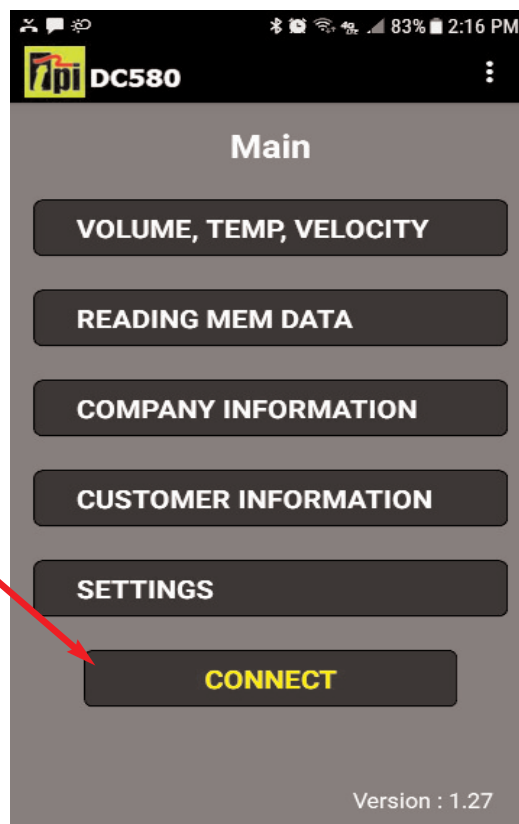



## Using the DC580 App (Continued)

4. Available DC580's will be displayed.
5. Tap on an available DC580 and the app will return to the main display.

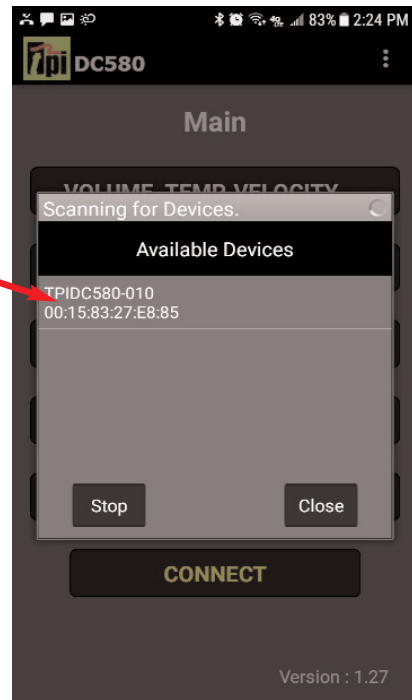

From the main display many functions can be accessed.

The real time Air Volume, Air Velocity, and Temperature can be displayed.

Readings stored in the DC580 memory can be downloaded and seen.

Your company information can be entered into the app. This information will show up on email reports.

The customer information can be entered into the app, This information will show up on email reports.

Settings like if a grille is present or what type of duct is being tested can be entered.

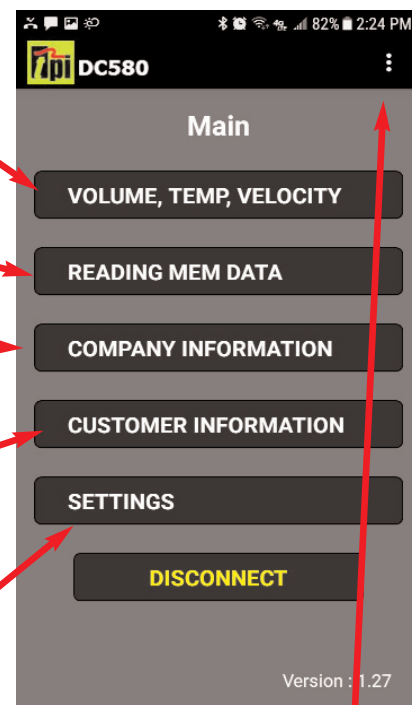

All of these can also be accessed from the drop down menu tab.

## Using the DC580 App (Continued)

Tap on “Volume, Temp, Velocity” to see the real time readings.

From this screen the auto power off, units of measure, and duct type / size can be changed by tapping on the icons and entering the data.

This information will be transmitted to the DC580.

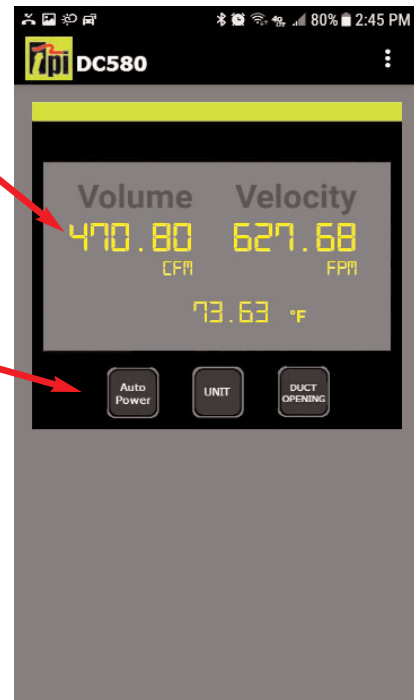

Tap on “Reading Mem Data” to download all saved readings from the memory of the DC580.

Tap on “Update All” to begin the download. The memory locations being downloaded will be displayed. Only locations with data will download.

Tap on a memory location to see the information contained in it. (See next page)

NOTE: Downloading information from the DC580 does not delete the data on the DC580. To do this either store over older data or perform a memory clear as outlined on page 11.

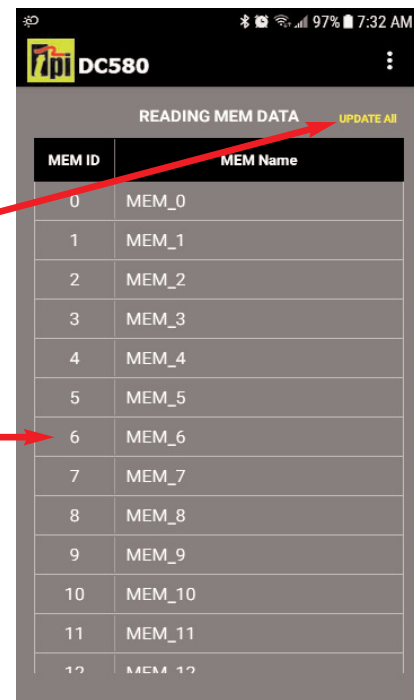

## Using the DC580 App (Continued)

After tapping on “Reading Mem Data” and tapping “Update All” the data stored in the DC580 will download.

Tapping on a memory location will display the information stored there.

From here a CSV file can be created and stored on the phone by tapping CSV or the CSV file can be created and emailed by tapping email.

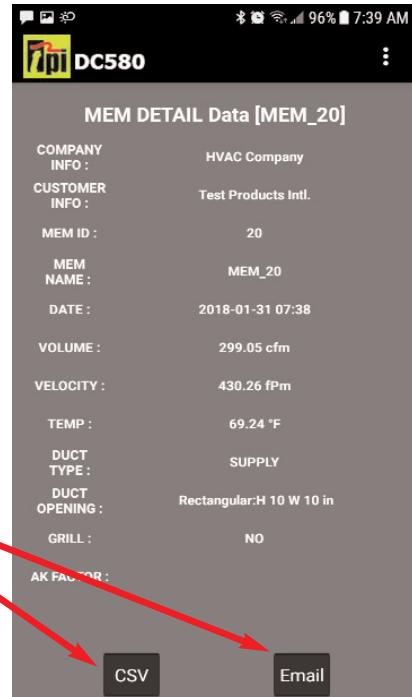

Tap on “Company Information” to open the Company Info input screen. This is where your company name, address, and email should be entered.

This information will be part of the CSV report generated that you can email your customer.

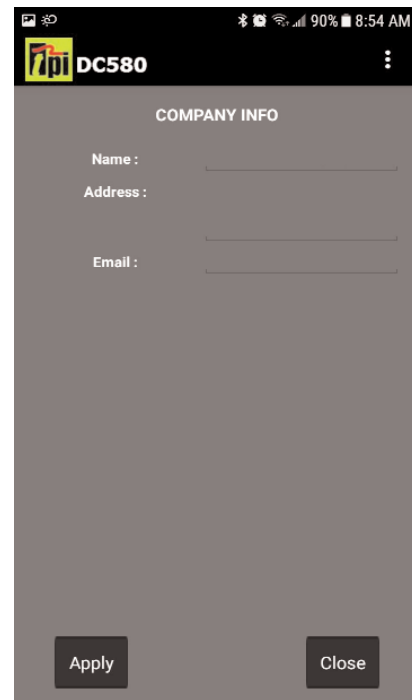

## Using the DC580 App (Continued)

Tap on “Customer Information” to open the Customer Info input screen. This is where your customer’s name, address, and email should be entered.

The building information can also be entered as necessary.

This information will be part of the CSV report generated that you can email your customer.

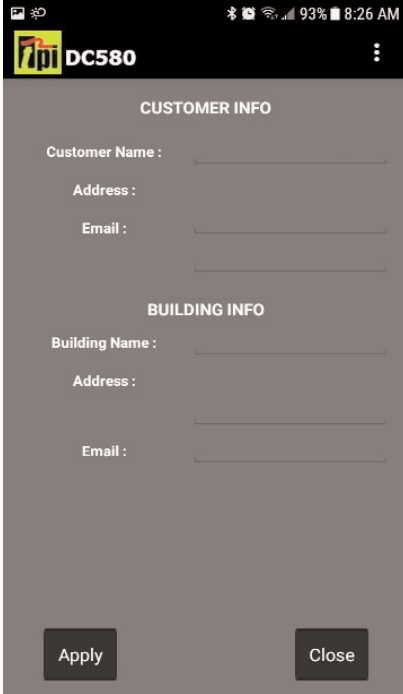

The screenshot shows the DC580 app interface for entering customer and building information. The screen is titled "CUSTOMER INFO" and "BUILDING INFO". It features two sections: "CUSTOMER INFO" and "BUILDING INFO". Each section has three input fields: "Customer Name", "Address", and "Email". At the bottom of the screen, there are two buttons: "Apply" and "Close". The status bar at the top shows the time as 8:26 AM and a battery level of 93%.

Tap on “Settings” to open the Settings input screen. This is where you select whether there was a grille in place and what type of duct was being measured.

This information will be part of the CSV report generated that you can email your customer.



The screenshot shows the DC580 app interface for entering settings. The screen is titled "SETTINGS". It features two sections: "COMPANY INFO" and "CUSTOMER INFO". The "COMPANY INFO" section has two input fields: "GRILL" and "DUCT TYPE". The "GRILL" field has a button labeled "NO" and the "DUCT TYPE" field has a button labeled "SUPPLY". At the bottom of the screen, there are two buttons: "Apply" and "Close". The status bar at the top shows the time as 8:26 AM and a battery level of 93%.

# Specifications

Function	Description	
Hotwire Air	Range	39 fpm to 3900 fpm (0.2 m/s to 20 m/s)
	Resolution	1 fpm (0.01 m/s)
	Accuracy	$\pm( 5\% + 10 \text{ digit } )$ or $\pm( 1\% + 10 \text{ digit } )$ F.S whichever is greater
	Unit	m/s, km/h, mph, fpm
Vane Air	Range	78 fps to 4900 fps (0.4 m/s to 25 m/s)
	Resolution	1 fps (0.1 m/s)
	Accuracy	$\pm( 2\% + 3\text{digit } )$
	Unit	m/s, km/h, mph, fpm
Temperature	Range	-4°F to 140°F (-20°C to 60°C)
	Resolution	0.1°F (0.1°C)
	Accuracy	$\pm 3^{\circ}\text{F}$ (32°F to 113°F) / $\pm 1.5^{\circ}\text{C}$ ( 0 °C ~ 45 °C ) $\pm 4^{\circ}\text{F}$ (< 32°F and > 113°F) / $\pm 2^{\circ}\text{C}$ (< 0°C and > 45°C)
Others	Airflow(volume) Units	CFM, CMM.
	Additional Functions	REC, MIN, MAX, AVG, Data HOLD
	Operating Temp. & Humidity	-4 °F ~ 140 °F (-20 °C ~ 60 °C) at <75%RH non-condensing
	Communication	Bluetooth LE
	Battery	4.5V ( AA size x 3)
	Battery Life	Hot air probe : about. 30h Vane air probe : about. 68h Reduced when Bluetooth is active
	Auto power off	15 min ( if APO is active )
	Hot Wire Probe	Sensor Diameter: 0.453" (11.5mm) Probe Extension Length: 37.75" (960mm)
	Vane Probe	Probe Diameter: 2.83" (72mm)
	Size	W x L x D 2.9" x 6.6" x 1.6" (73.5mm x 167.5mm x 41.5mm)
	Weight	0.8 lb (363g)

# Specifications (Continued)

## Optional Accessories

<u>Part Number</u>	<u>Description</u>
A103	Boot hook for hanging the DC580
A124	Magnetic hanger strap for hanging the DC580

## Replacement Parts

<u>Part Number</u>	<u>Description</u>
DC580	Meter only
A580	Carrying case for DC580
A581	Hotwire probe for DC580
A582	Vane probe for DC580
A583	Protective boot with magnets

## Battery Replacement

1. Remove the DC580 from the protective boot by prying the boot off from the bottom of the meter first.
2. Locate and loosen the battery cover screw.
3. Remove the battery cover and replace the batteries (AA x 3).
4. Install the battery cover and tighten the cover screw. Install the protective boot at starting by inserting the top of the meter into the boot first.



# Troubleshooting

<u>Problem</u>	<u>Possible Solution</u>
DC580 will not turn on	Change the battery. Press and hold the  key.
Display reads OPEN	Connect a probe to the input. Probe may be bad; Return for service.
Cannot connect Bluetooth	Turn Bluetooth on, see page 30. Make sure phone Bluetooth is on.
Readings seem to be high or low	Change batteries. Ensure white dot is facing into the air stream.

## Care & Cleaning

Clean the DC580 with a soft lint free cloth. Do not attempt to clean the sensor. Use a mild detergent on the base unit if necessary.

Do not submerge the DC580 or probes.

## Warranty, Service, and Calibration

The TPI DC580 air velocity meter is guaranteed free from defects in materials and workmanship for 3 Years from the date of purchase. This guarantee does not affect your statutory rights. For additional information please refer to the included warranty card or contact TPI at 800-368-5719.. To maintain optimum performance, calibration is recommended once every year.

To obtain warranty performance, service or calibration of your meter: -  
Include with the product your name, address, phone number, written description of the problem and proof of purchase date. Carefully package and return to:

TPI / Attn. Service  
9615 SW Allen Blvd. Suite 104  
Beaverton, OR 97005

**Test Products International, Inc.**

9615 SW Allen Blvd., Ste. 104  
Beaverton, OR 97005  
Tel: 503-520-9197 Fax: 503-520-1225  
[www.testproductsintl.com](http://www.testproductsintl.com)

**Test Products International, Ltd.**

342 Bronte Road South, Unit #6  
Milton Ontario Canada L9T5B7  
Tel: 905-693-8558 Fax: 905-693-0888  
[www.tpicanada.com](http://www.tpicanada.com)

**Test Products International Europe Ltd.**

Longley House International Drive  
Southgate Crawley  
West Sussex RH10 6AQ  
Tel: +44 (0) 1293 530196 Fax: +44 (0) 1293 531870  
[www.tpieurope.com](http://www.tpieurope.com)